

Modern Processor Architecture

Lecture Goals

- Learn about the key techniques that modern processors use to achieve high performance
- Emphasize the techniques that may help you in the design project (e.g., simple branch prediction)

Reminder: Processor Performance

$$\frac{\text{Time}_{\text{Program}}}{\text{Instructions}_{\text{Program}}} = \frac{\text{Cycles}_{\text{Instruction}}}{\text{CPI}} \cdot \frac{\text{Time}_{\text{Cycle}}}{t_{\text{CLK}}}$$

- Pipelining lowers t_{CLK} . What about CPI?
- $\text{CPI} = \text{CPI}_{\text{ideal}} + \text{CPI}_{\text{hazard}}$
 - $\text{CPI}_{\text{ideal}}$: cycles per instruction if no stalls
- $\text{CPI}_{\text{hazard}}$ contributors
 - Data hazards: long operations, cache misses
 - Control hazards: branches, jumps, exceptions

Standard 5-Stage Pipeline

- Assume full bypassing
- $CPI_{ideal} = 1.0$
- CPI_{hazard} due to data hazards:
Up to how many cycles lost to each load-to-use hazard? 2
- CPI_{hazard} due to control hazards:
How many cycles lost to each jump and taken branch? 2

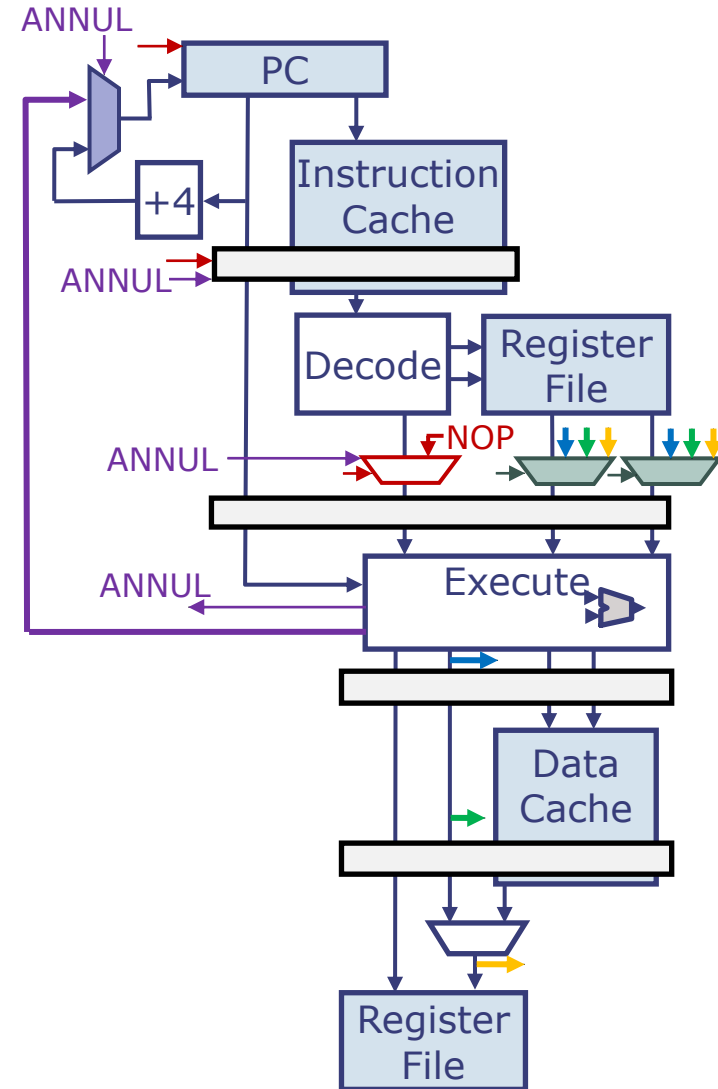

Improving Processor Performance

- Increase clock frequency: **deeper pipelines**
 - Overlap more instructions
- Reduce CPI_{ideal} : **wider pipelines**
 - Each pipeline stage processes multiple instructions
- Reduce impact of data hazards: **out-of-order execution**
 - Execute each instruction as soon as its source operands are available
- Reduce impact of control hazards: **branch prediction**
 - Predict both direction and target of branches and jumps

Deeper Pipelines

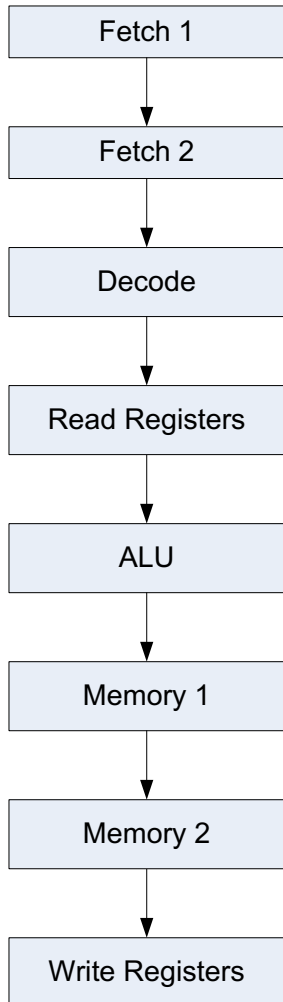

- Break up datapath into N pipeline stages
 - Ideal $t_{\text{CLK}} = 1/N$ compared to non-pipelined
 - So let's use a large N!
- Advantage: Higher clock frequency
 - The workhorse behind multi-GHz processors
 - Intel Skylake, AMD Zen2: 19 stages, 4-5 GHz
- Disadvantages
 - More overlapping \Rightarrow more dependencies
 - $\text{CPI}_{\text{hazard}}$ grows due to data and control hazards
 - Pipeline registers add area & power

Wider (aka Superscalar) Pipelines

- Each stage operates on up to W instructions each clock cycle
- Advantage: Lower CPI_{ideal} ($1/W$)
 - Skylake & Zen2: 6-wide, Apple M1: 8-wide
- Disadvantages
 - Parallel execution \Rightarrow more dependencies
 - CPI_{hazard} grows due to data and control hazards
 - Much higher cost & complexity
 - More ALUs, register file ports, ...
 - Many bypass & stall cases to check

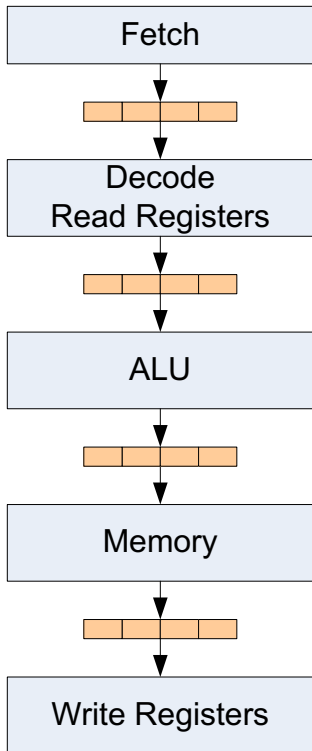

Resolving Hazards

- Strategy 1: Stall. Wait for the result to be available by freezing earlier pipeline stages
- Strategy 2: Bypass. Route data to the earlier pipeline stage as soon as it is calculated
- Strategy 3: Speculate
 - Guess a value and continue executing anyway
 - When actual value is available, two cases
 - Guessed correctly → do nothing
 - Guessed incorrectly → kill & restart with correct value
- Strategy 4: Find something else to do

Out-of-Order Execution

- Consider the expression $D = 3(a - b) + 7ac$

Sequential code

```
ld a
ld b
sub a-b
mul 3(a-b)
ld c
mul ac
mul 7ac
add 3(a-b)+7ac
st d
```

Dataflow graph

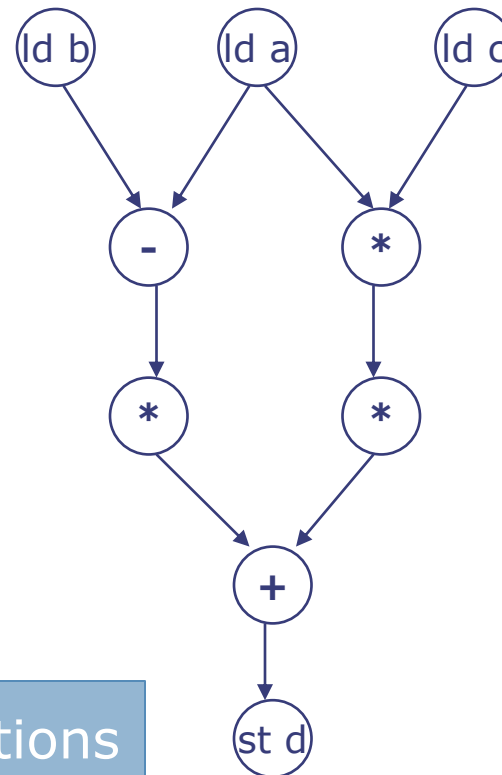

Out-of-order execution runs instructions as soon as their inputs become available

Out-of-Order Execution Example

- If `ld b` takes a few cycles (e.g., cache miss), can execute instructions that do not depend on `b`

Sequential code

```
ld a  
→ ld b  
sub a-b  
mul 3(a-b)  
ld c  
mul ac  
mul 7ac  
add 3(a-b)+7ac  
st d
```

Dataflow graph

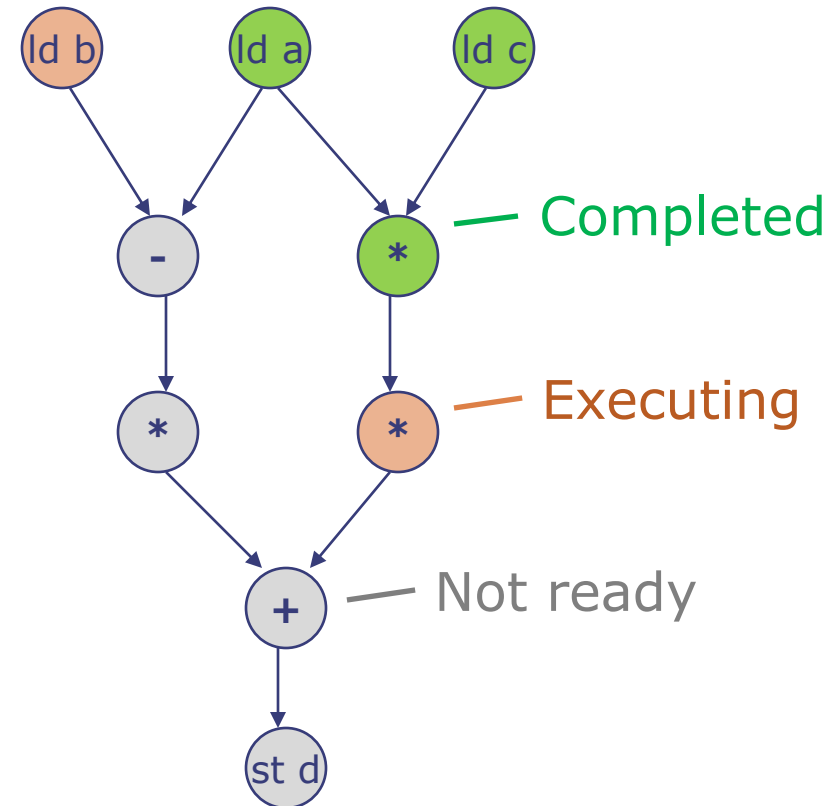

A Modern Out-of-Order Superscalar Processor

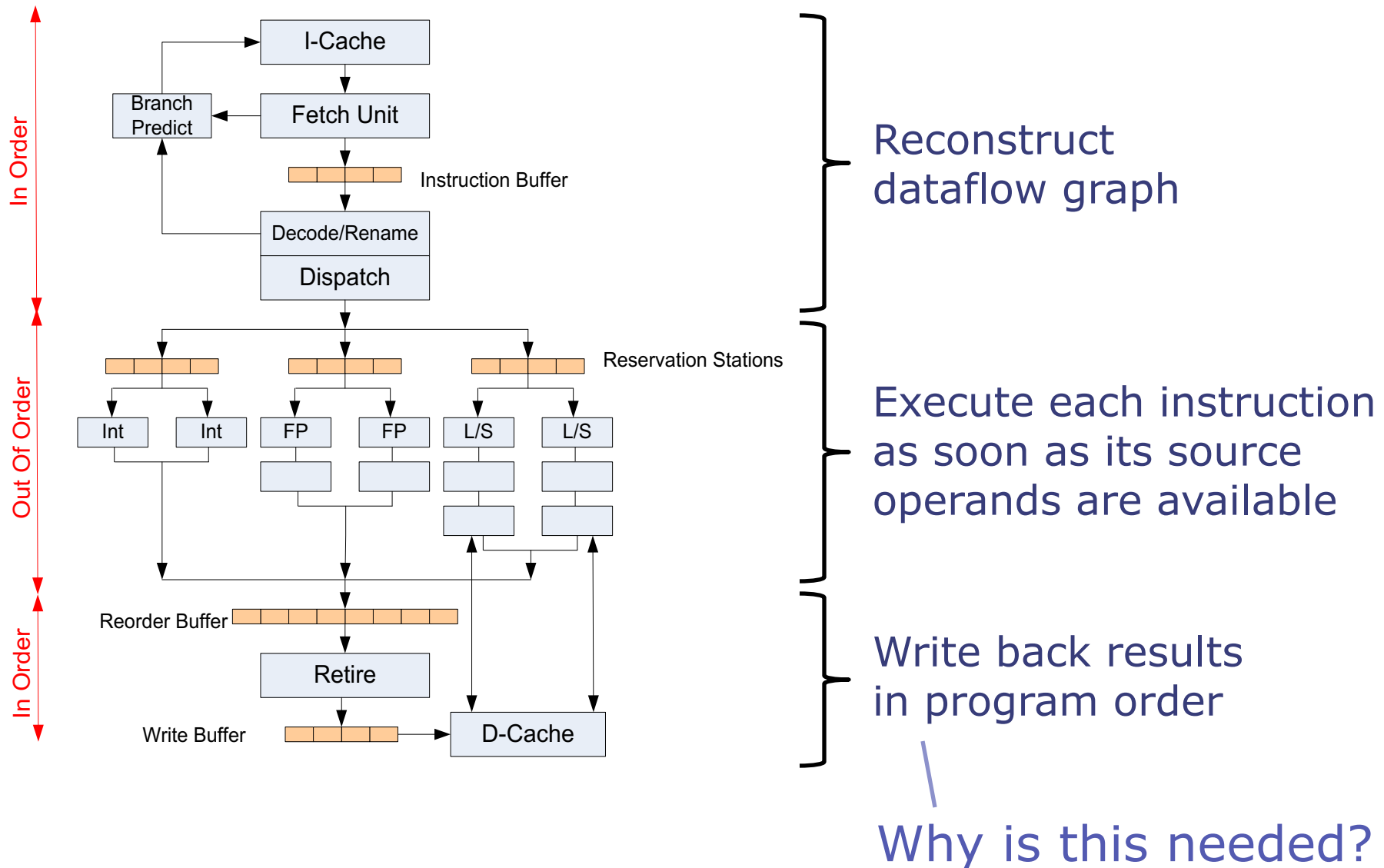

Control Hazard Penalty

- Modern processors have >10 pipeline stages between next PC calculation and branch resolution!
- How much work is lost every time pipeline does not follow correct instruction flow?

Loop length x Pipeline width

- One branch every 5-20 instructions... performance impact of mispredictions?

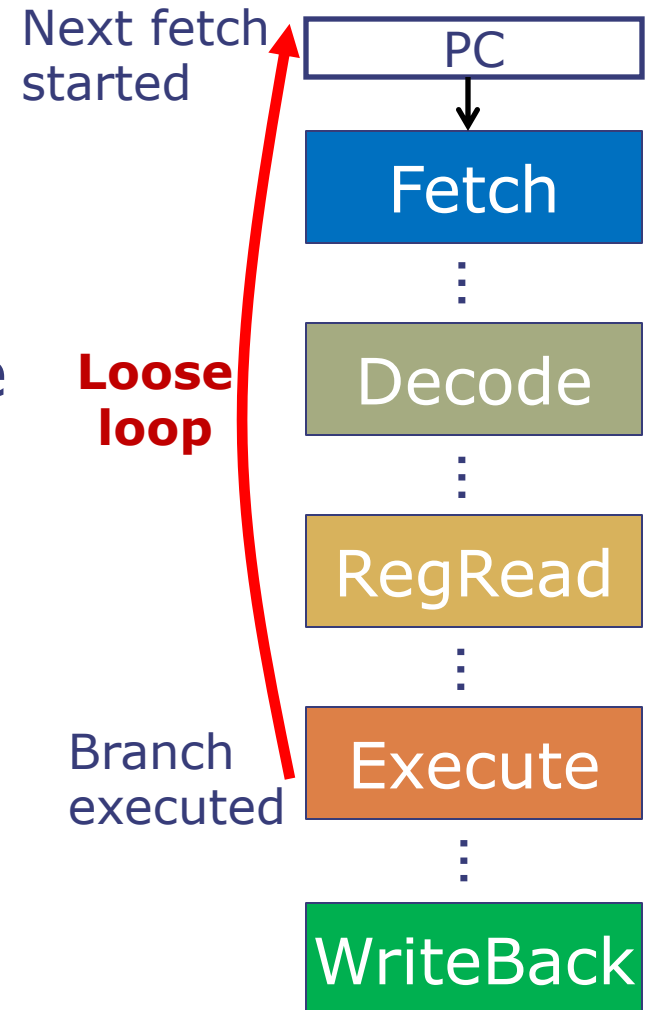

RISC-V Branches and Jumps

- Each instruction fetch depends on information from the preceding instruction:
 - 1) Is the preceding instruction a taken branch or jump?
 - 2) If so, what is the target address?

<i>Instruction</i>	<i>Taken known?</i>	<i>Target known?</i>
JAL	After Inst. Decode	After Inst. Decode
JALR	After Inst. Decode	After Inst. Execute
Branches	After Inst. Execute	After Inst. Decode

Resolving Hazards

- Strategy 1: Stall. Wait for the result to be available by freezing earlier pipeline stages
- Strategy 2: Bypass. Route data to the earlier pipeline stage as soon as it is calculated
- Strategy 3: Speculate Predict jump/branch target and direction
 - Guess a value and continue executing anyway
 - When actual value is available, two cases
 - Guessed correctly → do nothing
 - Guessed incorrectly → kill & restart with correct value
- Strategy 4: Find something else to do

Static Branch Prediction

- Probability a branch is taken is $\sim 60-70\%$, but:

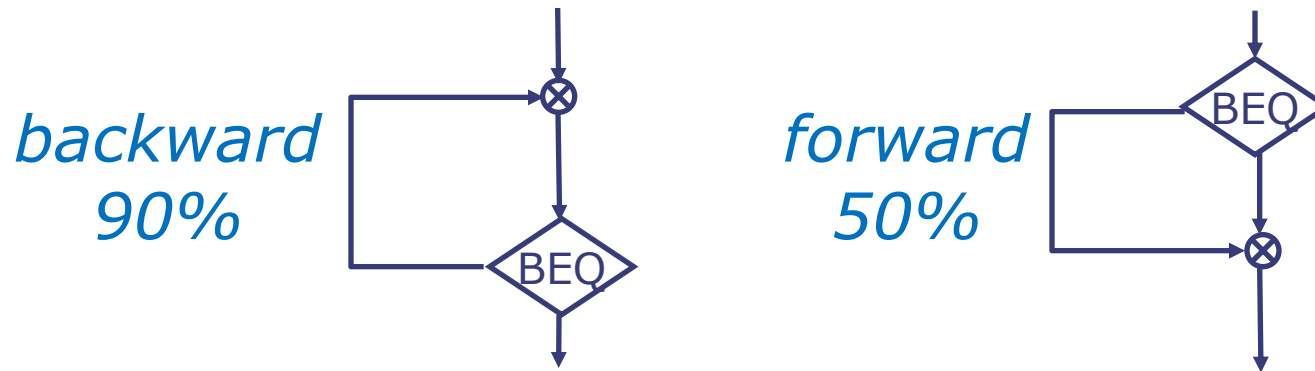

- Some ISAs attach preferred direction hints to branches, e.g., Motorola MC88110
 - bne0 (preferred taken)* *beq0 (not taken)*
- Achieves $\sim 80\%$ accuracy

Good way to improve CPI on part 3 of the design project if you use a 4-stage pipeline

Dynamic Branch Prediction

Learning from past behavior

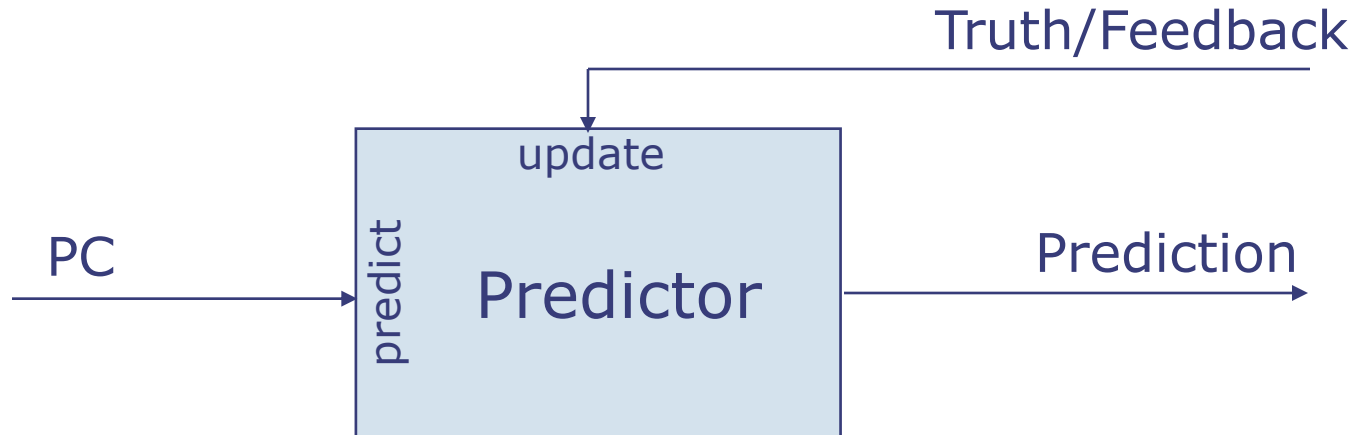

- Temporal correlation
 - The way a branch resolves may be a good predictor of the way it will resolve at the next execution
- Spatial correlation
 - Several branches may resolve in a highly correlated manner (a preferred path of execution)

Predicting the Target Address: Branch Target Buffer (BTB)

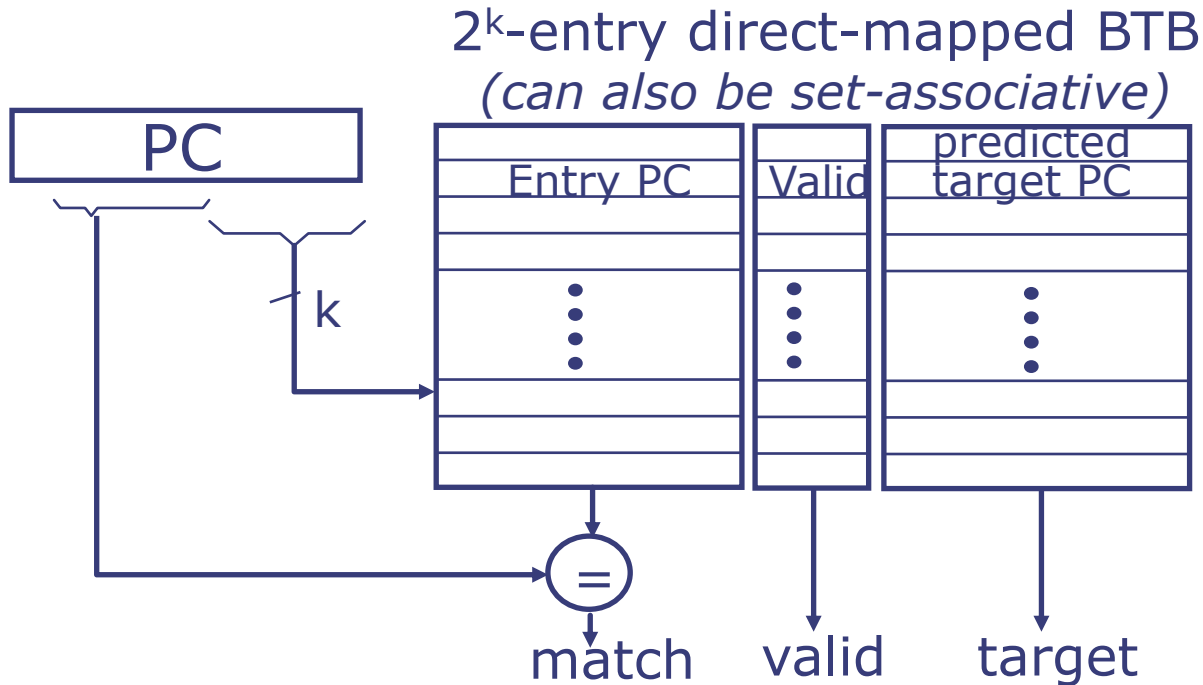

- BTB is a cache for targets: Remembers last target PC *for taken branches and jumps*
 - If hit, use stored target as predicted next PC
 - If miss, use PC+4 as predicted next PC
 - After target is known, update if prediction is wrong

Integrating the BTB in the Pipeline

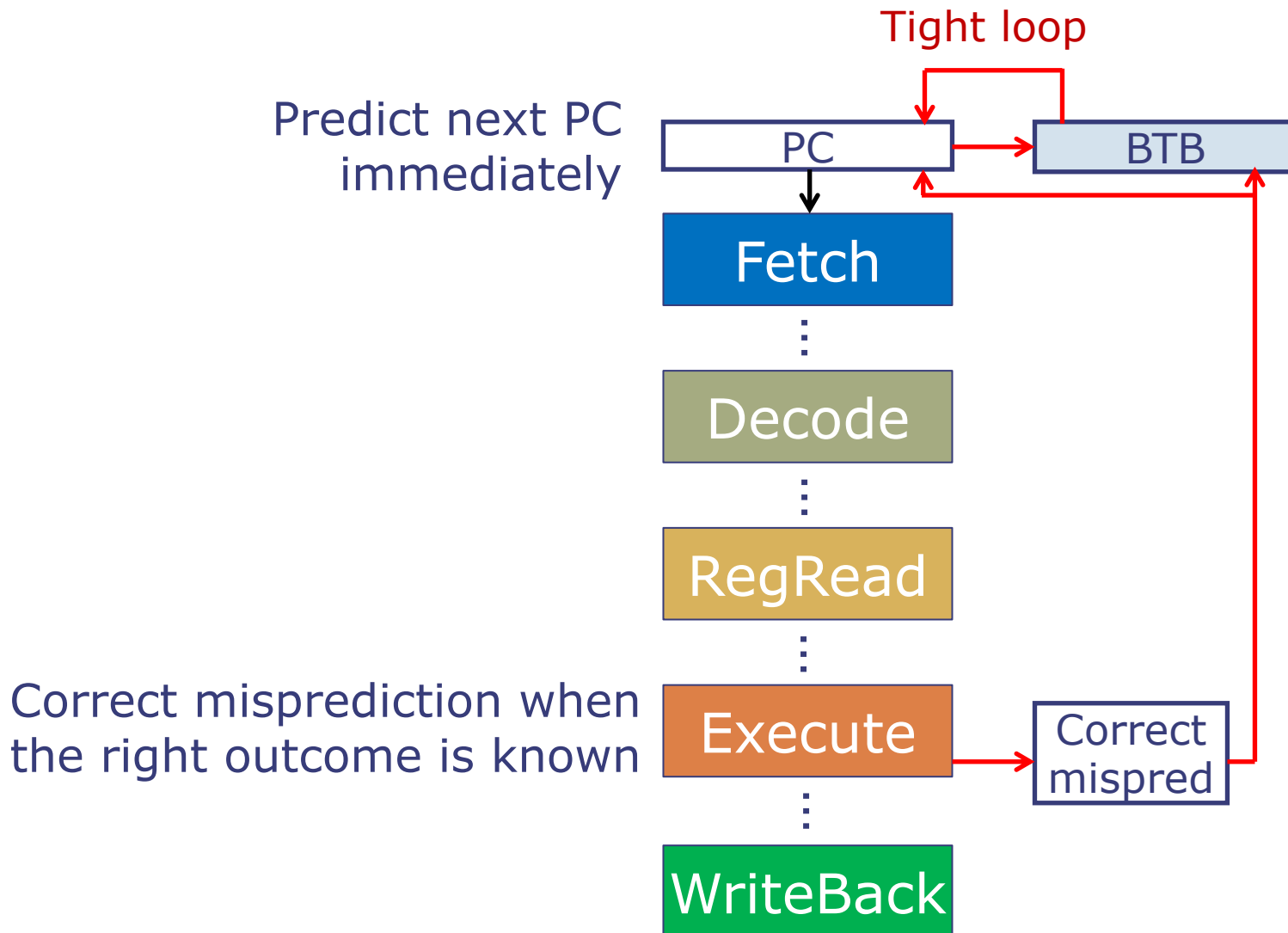

BTB Implementation Details

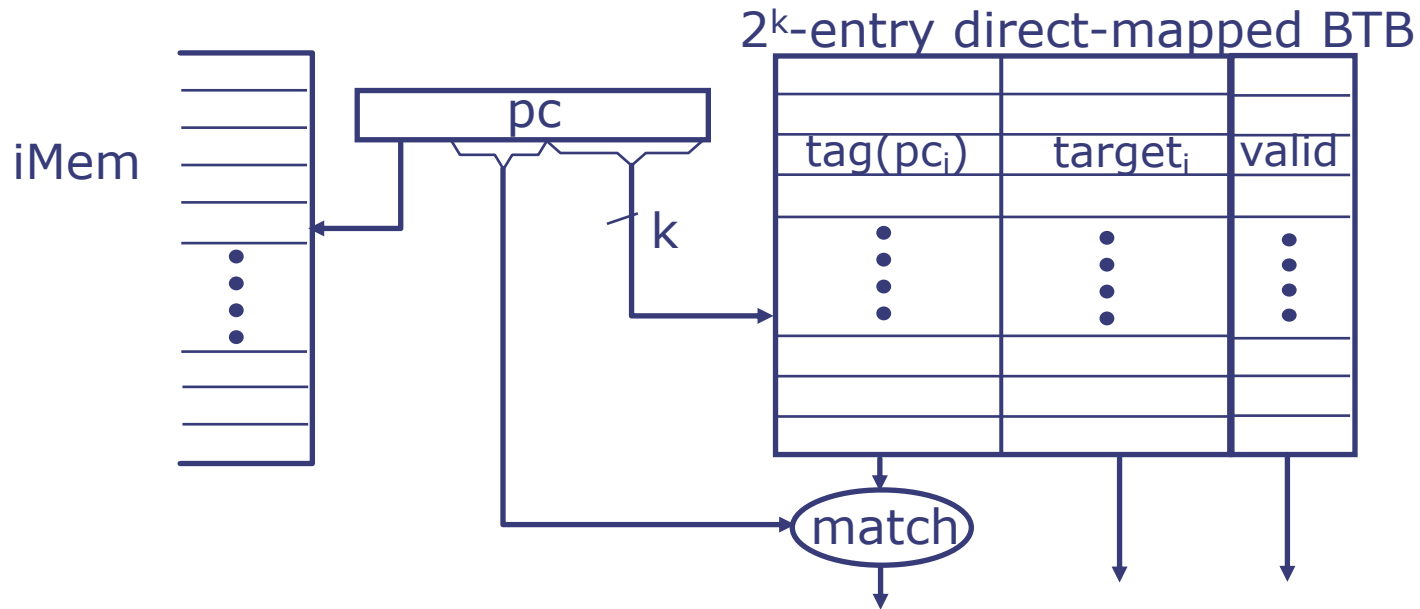

- Unlike caches, it is fine if the BTB produces an invalid next PC
 - It's just a prediction!
- Therefore, BTB area & delay can be reduced by
 - Making tags arbitrarily small (match with a subset of PC bits)
 - Storing only a subset of target PC bits (fill missing bits from current PC)
 - Not storing valid bits
- Even small BTBs are very effective!

BTB Interface

```
typedef struct
  { Word pc; Word nextPc; Bool taken; } UpdateArgs;
module BTB;
  method Addr predict(Addr pc);
  input Maybe#(UpdateArgs) update default = Invalid;
endmodule
```

- *predict*: Simple lookup to predict nextPC in Fetch stage
- *update*: On a pc misprediction, if the jump or branch at the pc was taken, then the BTB is updated with the new (pc, nextPC). Otherwise, the pc entry is deleted.

A BTB is a good way to improve CPI
on part 3 of the design project
(and has lower t_{CLK} than static prediction)

Better Branch Direction Prediction

- Consider the following loop:

```
loop: ...  
      addi a1, a1, -1  
      bnez a1, loop
```

- *How many mispredictions does the BTB incur per loop?*
 - *One on loop exit*
 - *Another one on first iteration*

Two-Bit Direction Predictor

Smith 1981

- Use two bits per BTB entry instead of one valid bit
- Manage them as a saturating counter:

On not-taken ↕	↕ On taken	1	1	Strongly taken
		1	0	Weakly taken
		0	1	Weakly not-taken
		0	0	Strongly not-taken

- Direction prediction changes only after two wrong predictions
- *How many mispredictions per loop?* 1

Modern Processors Combine Multiple Specialized Predictors

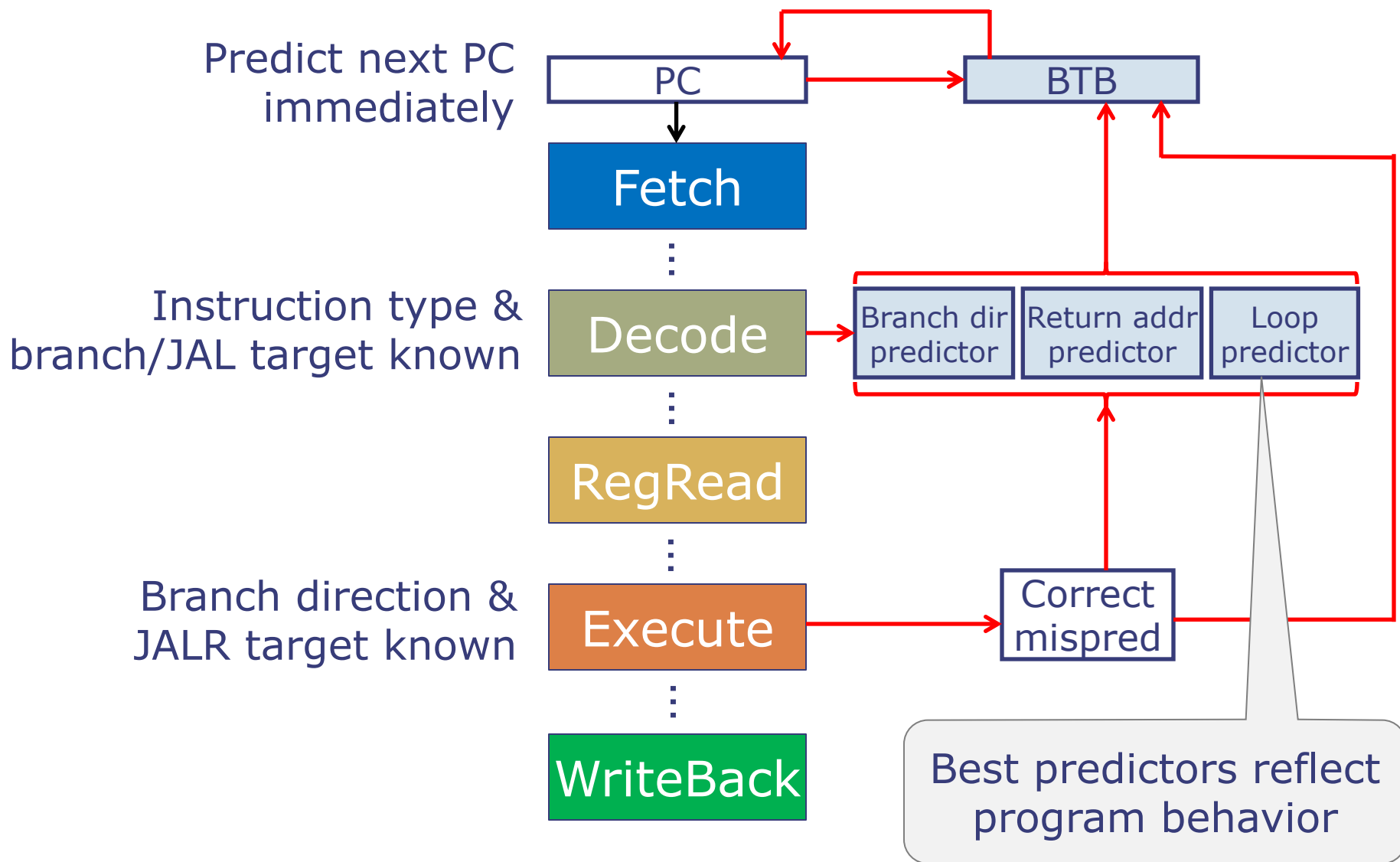

Putting It All Together: Intel Core i7 (Skylake)

- Each core has 19 pipeline stages, ~4GHz
- 6-wide superscalar
- Out of order execution
- Multi-level branch predictors
- Caches:
 - L1: 32KB I + 32KB D
 - L2: 256KB
 - L3: 8MB, shared
- Large overheads vs simple cores!

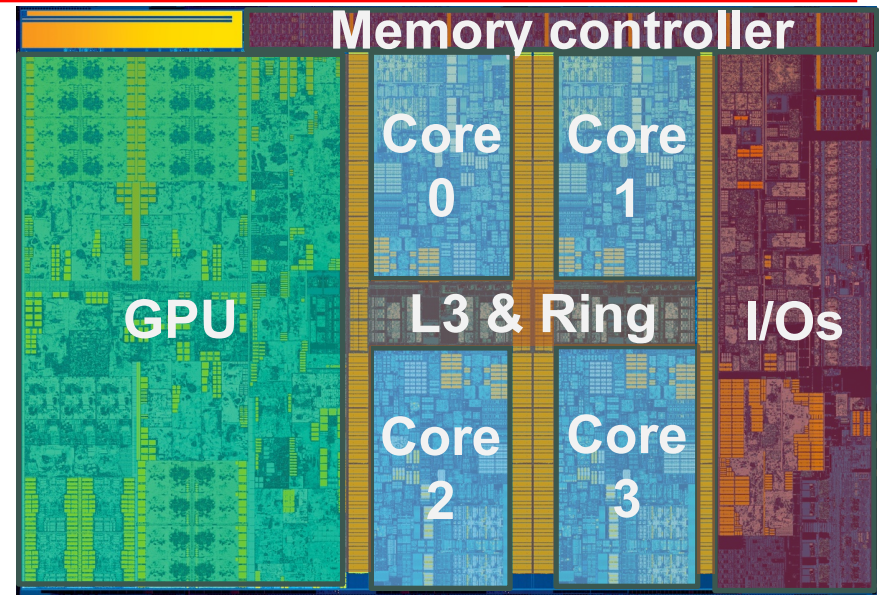

Intel, 2016, 14nm,
1.7B transistors, 122mm²

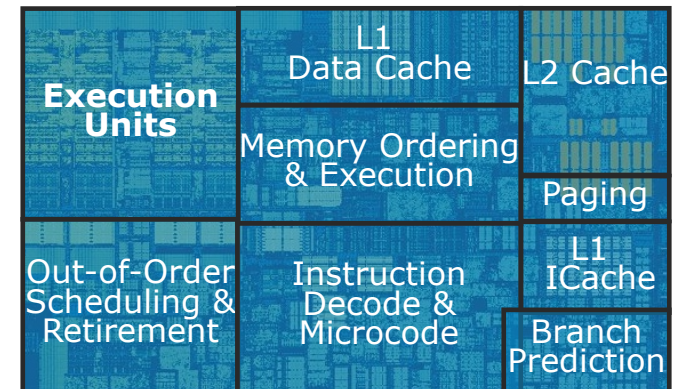

▪ Your RISC-V core

Design Project Leaderboard

- Available in Labs > DP > Leaderboard

6.191 Home Information Material Labs Help dnl

Welcome, dnl (No submission yet)

- We will take your most recent submission from Didit
- All submissions are anonymous
- Lower values are better. For ties, we sort alphabetically
- Staff solutions may be included. Staff entries are **bold**
- Results are live as of the refresh time. If you want to get updates, just press "Refresh"

Last refresh: 12/6/2022, 11:59:07 AM [Refresh](#) [Hide staff](#) [Fetch all students \(this will take a while\)](#)

Ranking	Submitter	Part 1 Instructions \triangle	Part 2 CPI \triangle	Part 3 Runtime \blacktriangle
1	netburst alu	158496	1.33477797353862	79979
2	pdp-11 bht	114636	1.16212364354569	87794
3	sage itlb	155321	1.121942296686155	97520
4	sgi origin itlb	176322	1.157013163358059	114883
5	pentium fpu	157105	1.424237187328164	117578
6	ibm 360 rob	168428	1.33477797353862	124193
7	grace dtlb	177551	1.184318434312262	124469
8	sunny cove bht	183519	1.263996588524425	126904
9	cray-1 btb	159424	1.16212364354569	131417

Thank you!

Good luck on Quiz 3 😊